

# Sundance® Spas 880 Capri®

## Specifications

<b>Dimensions:</b> .....	69" x 82" x 30.5" (175.5 cm x 208.5 cm x 77.5 cm)	
<b>Seating Capacity:</b> .....	2-3 Adults	
<b>Dry Weight:</b> .....	635 lbs (288 kg)	
<b>Filled Weight (Spa Volume):</b> .....	3,262 lbs (1,480 kg)	
<b>Filled Weight (Average Fill):</b> .....	2,553 lbs (1,158 kg)	
<b>Water Capacity (Total Volume):</b> .....	315 US Gal (1,192 Liters)	
<b>Water Capacity (Average Fill):</b> .....	230 US Gal (871 Liters)	
<b>Controls:</b> .....	880 Touch Interface LCD Control, Displays Temperature, Time, Cycles and Jet/Air System Control. Offers Customizing of Filtration Cycles, Lighting, Water Temperature Setting and other features	
<b>Water Delivery:</b> .....	1 TheraMax High-Flow Pump and 8-Hour Dynamic Flow Circulation System	
<b>Pump 1:</b> .....	North America (60 Hz): 1-Speed/2.5 HP Continuous, 11.3A Max., 56 Frame <b>Export (50 Hz): 1-Speed/2.0 HP Continuous, 7.0A Max.</b>	
<b>Pump 2:</b> .....	High Output Dynamic Flow, 8-Hour Filter/Circulation Pump (35 gpm), Programmable for Daily Start Time and Duration	
<b>Total Hydrojets:</b> .....	<b>31</b>	
<b>Seat A Jets:</b> .....	6 Fluidix Reflex, 2 Pulsator, 4 Focus-Relief, 4 Accu-Pressure	
<b>Seat B Jets:</b> .....	10 Fluidix ST, 2 Fluidix Nex	
<b>Seat C Jets:</b> .....	1 Vortex, 2 Fluidix Intelli-Jet	
<b>Air Blower:</b> .....	High-Efficiency, 1-Speed	
<b>Aromatherapy Delivery:</b> .....	8 Air Injector Jets with Quiet High Speed Air Pump	
<b>Air Controls/Massage Selectors:</b> .....	2/1 (Standard air control with LED lights and massage selector with LED lights)	
<b>Filter:</b> .....	MicroClean® Ultra Filtration System, 130 ft <sup>2</sup> (2 interlocking cartridge filters)	
<b>Water Treatment:</b> .....	Automatic Brominator and Dynamic Flow Circulation System; Factory installed CLEARARRAY® Water Purification System and CLEARARRAY® PRO <sub>3</sub> TECT™	
<b>Lighting:</b> .....	Multi-Colored Sunglow LED Lighting System (1 Waterfall, 1 Main light, 2 Air controls, 1 Massage Selectors, Exterior lights)	
<b>Skirt Cabinet (SunSide™):</b> .....	Modern Hardwood, Brushed Gray and Vintage Oak (Equipped with Standard Exterior Lights)	
<b>Shell Colors:</b> .....	North America: Platinum, Celestite (Gypsum), Sahara, Monaco, Midnight, Porcelain <b>Export: All North America Colors</b>	
<b>Handrails:</b> .....	1 Integral	
<b>ComforTone Headrests:</b> .....	Three, 1-Piece Gray	
<b>Heater:</b> .....	North America (60 Hz): Low Flow 5.5 kW with Titanium Element <b>Export (50 Hz): Low Flow 2.7 kW with Titanium Element</b>	
<b>Electrical Requirements:</b> .....	North America (60 Hz): 240 VAC@40A or 50A; <b>Export (50 Hz): 230-240 VAC@1x25A, 2x16A (see manual for more configurations); or Suitably Rated Circuit Breaker to Comply with Local Electrical Regulations. Certain Countries May Require Dual Power Inputs; Two GFCI/RCD Breakers are Required for This Configuration.</b>	
<b>Limited Warranty*:</b> .....	North America (60 Hz): 10 Years Shell, 7 Years Shell Surface, 5 Years Plumbing Component Leaks, 5 Years Equipment and Controls, 5 Years Cabinet, 5 Years Jets, 2 Years Lights, 1 Year Stereo <b>Export (50 Hz): 10 Years Shell, 7 Years Shell Surface, 5 Years Plumbing Component Leaks, 5 Years Equipment and Controls, 5 Years Cabinet, 5 Years Jets, 2 Years Lights, 2 Years Stereo</b>	
<b>Waterfall Feature:</b> .....	Adjustable Flow Rate; Colored Lighting	
<b>Audio System (Optional):</b> .....	Factory Installed BLUEWAVE® 2.0 Wireless Spa Stereo System with Auxiliary 3.5 mm headphone jack connection, Bluetooth® compatible, 4 premium speakers and a powered subwoofer	
<b>Special Features:</b> .....	MicroClean® Plus Versatile Filter Lid, <b>Optional</b> Filter Lid Pillow seat, <b>Optional</b> (Factory Installed) SmartTub™ Module	

\*(See Warranty Document for Specific Details)

Dimensions/Specifications Subject To Change Without Notice

# Sundance Spas 880 Capri

## Operation/Seat Depths



- (A)** Air Control - Activates Seat A Jets (6 Fluidix Reflex, 2 Pulsator, 4 Focus Relief, 4 Accu-Pressure)
- (B)** Massage Selector - Adjusts Massage Level Between Seat A Jets and Seat C Jets + Seat B Jets
- (C)** Air Control - Activates Seat B Jets (2 Fluidix Nex, 10 Fluidix-ST) and Seat C Jets (1 Vortex, 2 Fluidix Intelli-Jet)
- (D)** Waterfall Selector [8-Hour Circ. Pump] - Controls Waterfall Output
- (E)** Sunscnt Dispenser

- Focus-Relief Jets: Work with both the blower and Jets Pump 2. The blower introduces air to the jet and the Jets Pump forces water through.

### 31 Total Jets

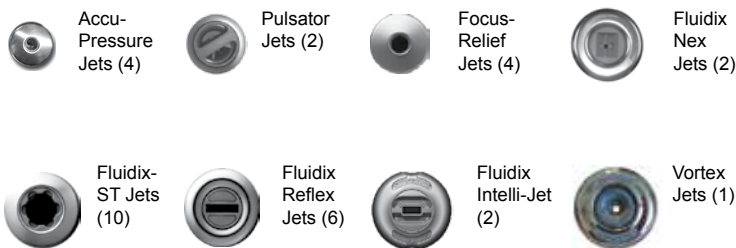

Spa Operation Subject To Change Without Notice

## SEAT DEPTHS

- A = 24.25" (61.60 cm)**
- B = 26.38" (66.99 cm)**
- C = 25.75" (65.41 cm)**
- D = 26.88" (68.26 cm)**

Listed dimensions represent distance from top of acrylic to lowest point in seat. **Tolerance ± 0.5" (1.27 cm).**



Dimensions/Specifications Subject To Change Without Notice

# Sundance Spas 880 Capri

## Portable Dimensions

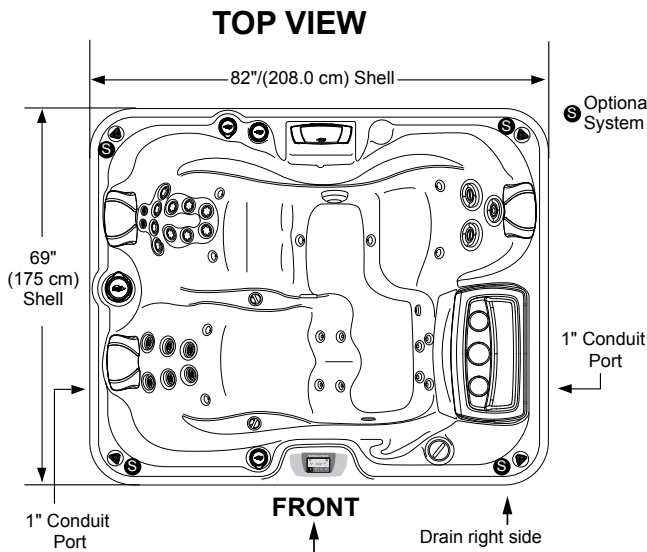

Equipment Bay/Pump Access behind skirt panels (CLEARRAY, Optional BLUEWAVE, and Optional SmartTub Module behind skirt panels)

**NOTE:** Over time the panel(s) may bow, this is considered normal. The panels will straighten out when reinstalled into the mounting channel. Place one end of the panel into the channel first then flatten the panel and insert the other end.

### FRONT/BACK VIEW

Tolerance:  $\pm 0.5"$  (1.27 cm)

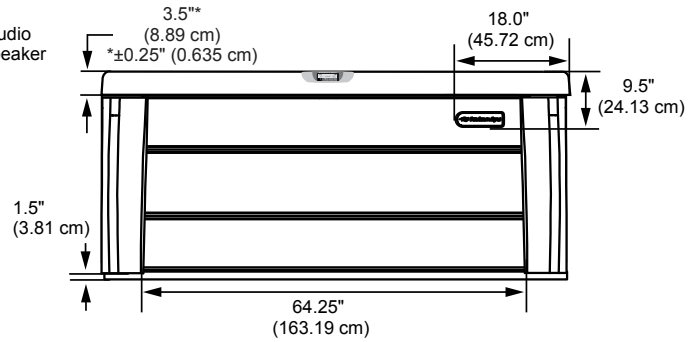

### LEFT/RIGHT SIDE VIEW (Left Side View Shown)

Tolerance:  $\pm 0.5"$  (1.27 cm)

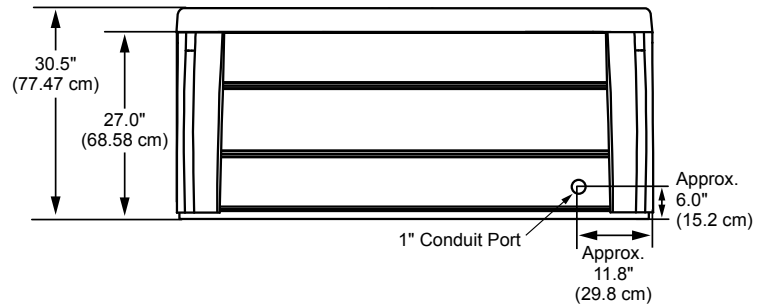

**IMPORTANT!** Always measure each hot tub for exact dimensions **BEFORE** designing its foundational support and/or decking.

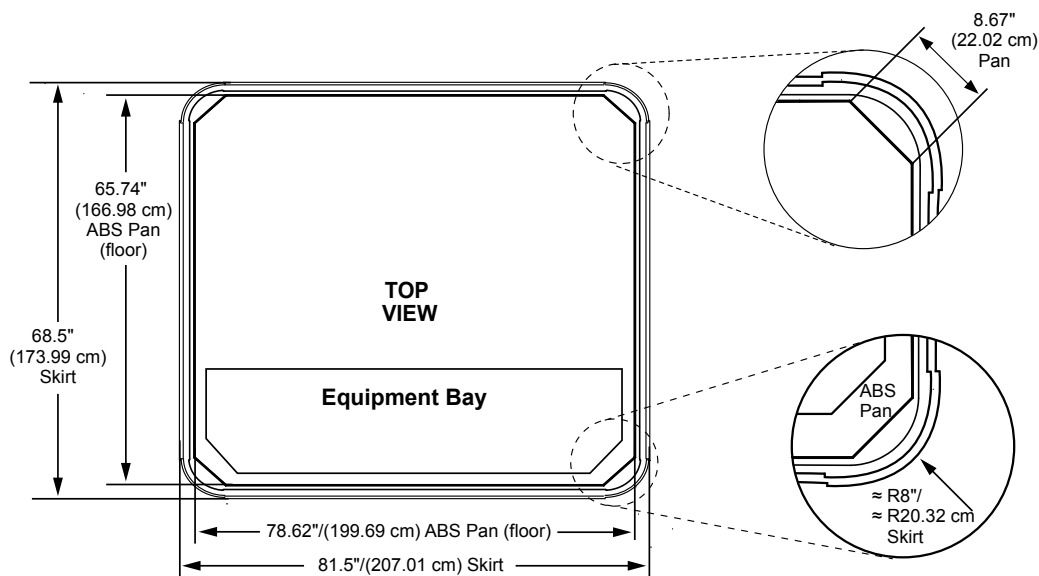

Dimensions/specifications subject to change without notice. Tolerance:  $\pm 0.5"$  (1.27 cm)

Dimensions/Specifications Subject To Change Without Notice

# SunSide Dimensions

Spa Models	DIMENSIONS A-F (All measurements are an approximate)					
	A	B	C* *±0.25" (0.635 cm)	D	E	F
Maxxus	41.5" (105.41 cm)	18.5" (46.99 cm)	5.5" (13.97 cm)	12.0" (30.48 cm)	32.5" (82.55 cm)	73.5" (186.69 cm)
Aspen						
Optima	37.5" (95.25 cm)		3.75" (9.53 cm)	8.0" (20.32 cm)	32.25" (81.92 cm)	71.5" (181.61 cm)
Cameo						
Altamar						
Cambria	34" (86.36 cm)		7.5" (19.05 cm)	28.75" (73.03 cm)	58.25" (147.95 cm)	
Marin						
Capri	30.5" (77.47 cm)	18" (45.72 cm)	3.5" (8.89 cm)	9.5" (24.13 cm)	25.5" (64.77 cm)	64.25" (163.19 cm)
DIMENSIONS G-I (All measurements are an approximate)						
	G	H	I	 <p><b>IMPORTANT! Always measure each hot tub for exact dimensions BEFORE designing its foundation support and/or decking.</b></p>		
Maxxus	8.0" (20.32 cm)	13.0" (33.02 cm)	3.5" (8.89 cm)			
Aspen						
Optima	7.0" (17.78 cm)	13.5" (34.29 cm)	1.5" (3.81 cm)			
Cameo						
Altamar						
Cambria	6.5" (16.51 cm)	13.0" (33.02 cm)	1.5" (3.81 cm)			
Marin						
Capri	4.0" (10.16 cm)	14.5" (36.86 cm)	1.5" (3.81 cm)			
- Dimensions Subject to Change Without Notice - Tolerance: ± 0.5" (1.27 cm)						

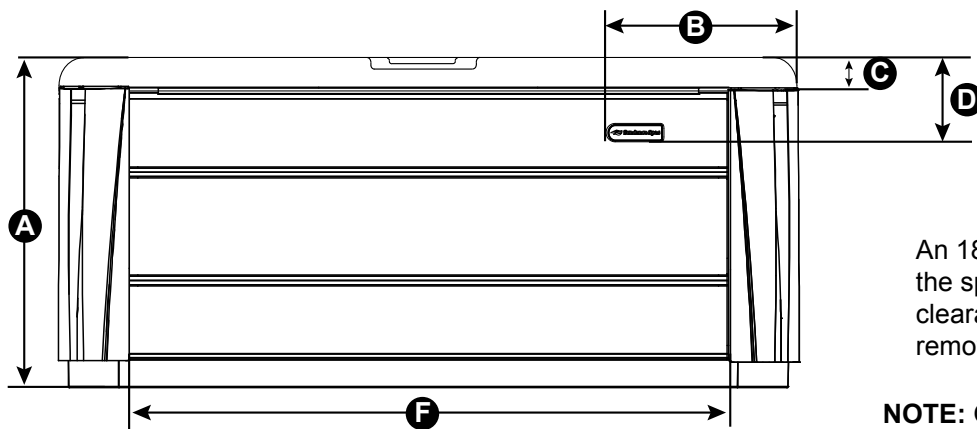

An 18" clearance, all around the spa, is recommended. This clearance is needed for panel removal or when servicing.

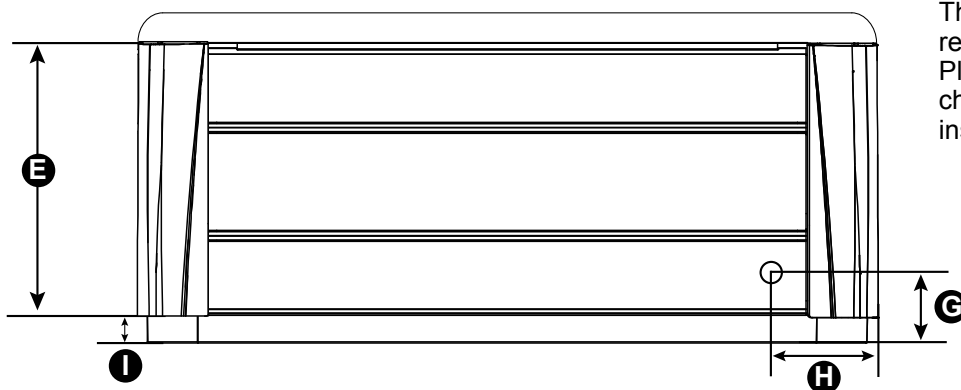

**NOTE:** Over time the panel(s) may bow, this is considered normal. The panels will straighten out when reinstalled into the mounting channel. Place one end of the panel into the channel first then flatten the panel and insert the other end.

Tolerance: ± 0.5" (1.27 cm)

Denne modellen kan kobles med 1-fas 230V C-sikring (treg) og 3-fas (400 volt TN-nett - se egne linjer)

**880-serien:**

Capri:	For å få mest mulig glede av badet anbefaler vi høyeste kurs for optimal drift.			
	Type varmeelement	Alternativ tilkobling	Funksjon	Kretskortinnstillinger
Capri	5,5 kW	3-fas (400 volt TN-nett) 25 amp	Varmeelement og pumper kan brukes samtidig	Se brukermanual.
Capri	5,5 kW	40 amp eller 16 + 25 amp	Varmeelement og pumper kan brukes samtidig	Se brukermanual.
Capri	5,5 kW	25 amp	Begge pumpene kan brukes samtidig. Varmeelementet slår seg automatisk av når pumpene startes.	Se brukermanual.
Capri	2,7 kW	3-fas (400 volt TN-nett) 16 amp	Varmeelement og pumper kan brukes samtidig	Se brukermanual.
Capri	2,7 kW	25 amp eller 16 + 16 amp	Varmeelement og pumper kan brukes samtidig	Se brukermanual.
Capri	2,7 kW	16 amp	Varmeelementet slår seg av når pumpene startes.	Se brukermanual.